

Szauna kunyhó

	2600 mm		4000 mm
	9.6 m ²		1020 x 1900 mm
	2		220 x 660 mm
	Kunyhó		Skandináv fenyő
	2 - 4		1700 kg
	38 mm		Lapra szerelt 4 x 1.2 x 2.6 m Összeszerelt 4 x 2.4 x 2.5 m

Standard szett:

- Skandináv fenyő;
- Zsindely színe választható;
- Két szoba: szauna + öltöző;
- Hőálló üvegezés a hátsó falon;
- Dupla ajtó, duplán üvegezett ablakokkal;
- Üveg térelválasztó ajtó;
- Szauna padok;
- Öltöző padok;
- Hőálló lemez a kazán mögött.

Kiegészítők



22 literes víztartály fa tüzelésű kazánhoz
Közvetlenül a kazán fölött.
Gyorsan melegszik a víz, mivel a kiáramló gázok átfutnak a tartályon.



Támla

Éger vagy nyárfából.



Szauna lámpa

Védelem: P44. Izzó E14 (max. 40 W) nem tartozék



Biztonsági korlát, fa tüzelésű kályhákhoz

Éger vagy nyírfából. Biztonságot ad, hogy közvetlenül ne érhesse a kazánhoz.



Hő- és páratartalom mérő

A száraz szaunázás fontos kelléke.



Szauna lámpa ernyő

Fa lámpaernyő.
Mérete: 24.5 x 38 cm.



Biztonsági korlát elektromos kályhákhoz

Éger vagy nyírfából. Biztonságot ad, hogy közvetlenül ne érhesse a kazánhoz.



Víztároló dézsa (PP belső bevonattal, 4l)

Kimagaslóan kiváló minőségű anyagból. A belső burkolat jól tisztítható.



Akasztó

Kemény fából, profi kivitel.



Fejtámla









































Ergonómikus tervezés, kiváló minőség. A szaunák kényelmi tartozéka.



Fa adagoló kanál

Víz adagolásához, ergonómiailag alakított.

Szauna kályhák

Harvia Vega BC80		 8 kW		 400V		 5-14 m ³
Harvia Vega BC90		 9 kW				
Harvia Vega BC60		 6 kW				
Harvia Club 13.5		 13.5 kW		 400V		 11-20 m ³
Harvia M3		 16.5 kW				 4.5-13 m ³
Harvia Pro 20		 24.1 kW				 8-20 m ³
Harvia M3 SL		 16.5 kW				 8-20 m ³
Harvia SL20		 24.1 kW				 8-20 m ³
Standard kémény szett		CE jelöléssel ellátott kémény szett. (1856-1 EN Európai Standard Minősítés. Rozsdamentes acélból. Ellenáll 450 C-kiáramló gáznak. Külső átmérője: 20 cm, belső átmérője 11.5 cm.				
„Luxus“ kémény szett		CE jelöléssel ellátott kémény szett. (1856-1 EN Európai Standard Minősítés. Fényes, rozsdamentes acélból. AISI 316, AISI 304-es standard / szigetelés Külső átmérője: 17 cm, belső átmérője 11.5 cm.				
„Harvia“ kémény szett		CE jelöléssel ellátott kémény szett. (1856-1 EN Európai Standard Minősítés. Rozsdamentes acélból. Szilárd tüzelésű anyagok legjobb hatásfokú gáztermék elvezetéséhez. Teljes magassága 5m.				



Dézsza fürdők

Dézsza

Skandináv fa

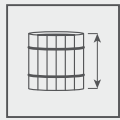

1050 mm

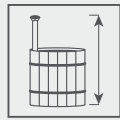

2390 mm

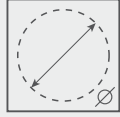

1.5 m
1.9 m
2.2 m



Kerek

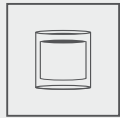

1600 l
2550 l
3420 l

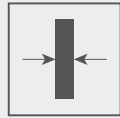

38 mm



Skandináv
fa



Hőkezelt fenyő



5 - 10



170 - 300 kg

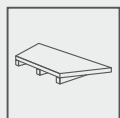

5 vagy 8

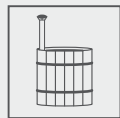

Lapra szerelt
2.2 x 1.2 x 0.63 m; 2 x 1.2 x 0.6 m
Összeszerelt
1.7 x 1.2 x 1.9 m; 2.1 x 1.2 x 2.2 m;
2.3 x 1.2 x 2.4 m

Standard szett:

- Meleg vizes dézsza skandináv fenyőből;
- Rozsdamentes feszítő pántok;
- Rozsdamentes acélkazán, (külső, vagy belső);
- Fa belső padozat;
- Biztonsági fa korlát belső kazánhoz;
- Vízleengedő szelep;
- Lépcső.

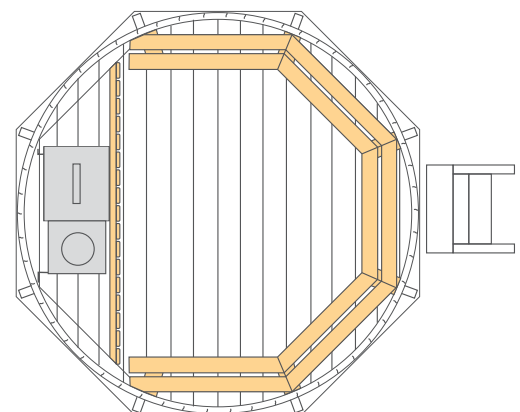
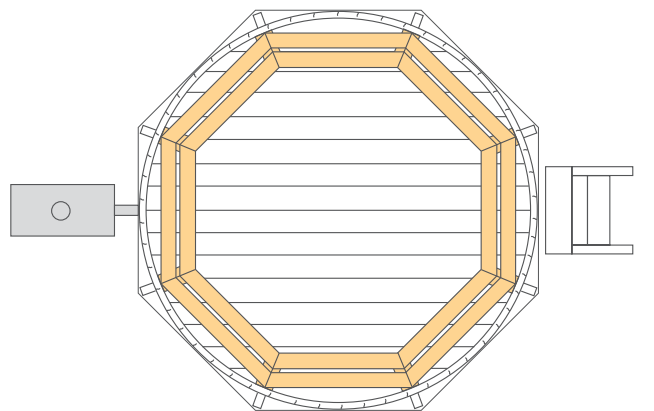



Dézsza

Polipropilén

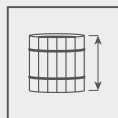

950 mm

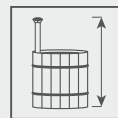

2390 mm

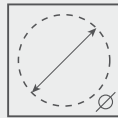

1.5 m
1.9 m
2.2 m

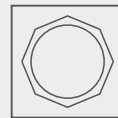

Kerek

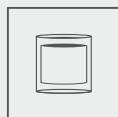

1600 l
2550 l
3420 l

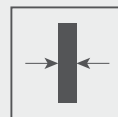

12 + 8 mm



Skandináv
fenyő



Hőkezelt skandináv
fenyő



5 - 10



200 - 250 kg

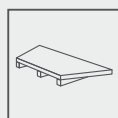

5 vagy 8

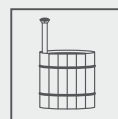
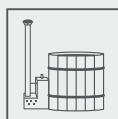

Összeszerelve
1.6 x 1.2 x 1.8 m; 2 x 1.2 x 2.1 m;
2.3 x 1.2 x 2.4 m

Standard szett:

Fa dézsza PP belsővel;
Meleg vizes dézsza skandináv fenyőből;
Rozsdamentes feszítő pántok;
Rozsdamentes acélkazán (külső, vagy
belső);
Fa belső padozat;
Biztonsági fa korlát belső kazánhoz;
Vízleengedő szelep;
Lépcső.

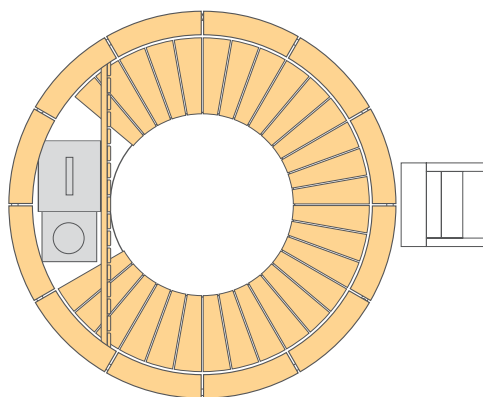
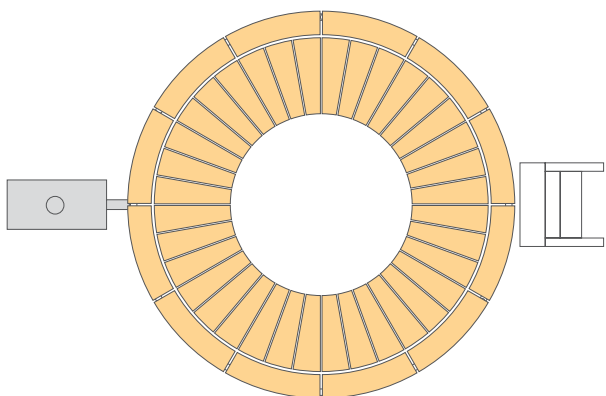

Dézsza

Üvegszövet

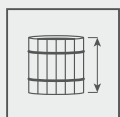

850 mm
1000 mm

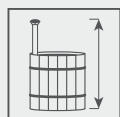

2390 mm

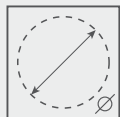

1.8 m



Kerek



1300 l
1600 l

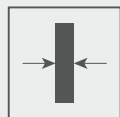

38 + ~3 mm



Skandináv
fenyő



4-8



200 - 230 kg

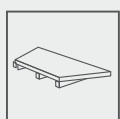
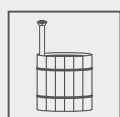

1

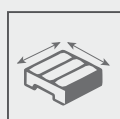

Összeszerelve
2.1 x 2.1 x 1.25

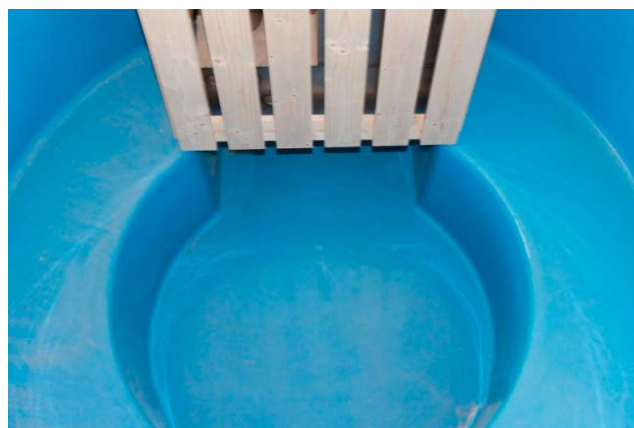

Standard szett:

Fa dézsza üvegszövet belsővel;
Meleg vizes dézsza skandináv
fenyőből; Rozsdamentes feszítő
pántok; Rozsdamentes acélkazán,
(külső, vagy belső);
Kompozit belső padozat;
Biztonsági fa korlát belső kazánhoz;
Vízleengedő szelep;
Lépcső.

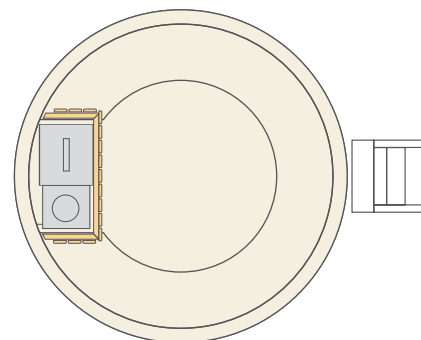
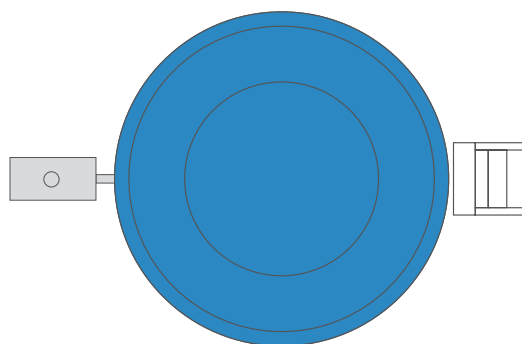

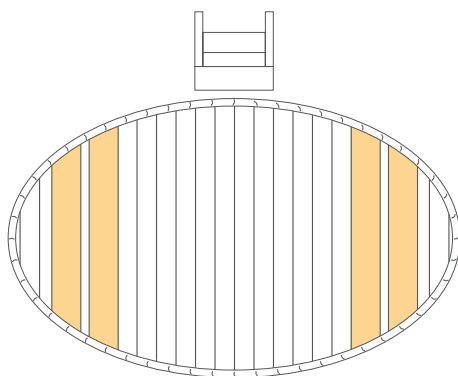
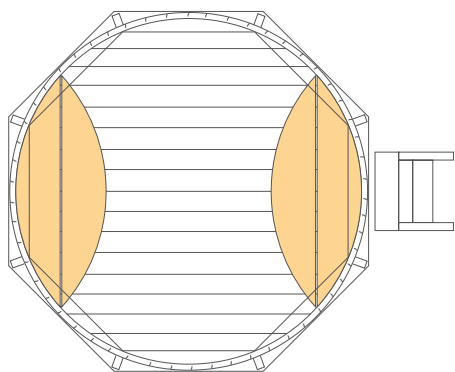

Dézsza

Ovális

Kerek

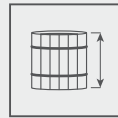

1000 mm

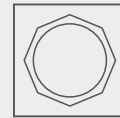

Kerek
Ovális

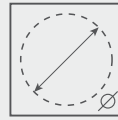

1.2 m

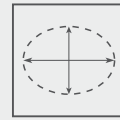

1500 x 850 mm



1600 l
2550 l

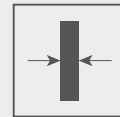

38 mm



Skandináv
fenyő



Hőkezelt fenyő



1 - 2



150 - 115 kg

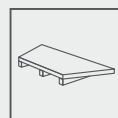

2



Lapra szerelt 1.1 x
1.4 x 0.6 m; 1.1 x
1.6 x 0.6 m
Összeszerelt
1.4 x 1.4 x 1.25 m;
1.1 x 1.6 x 0.95 m

Standard szett:

Fa hideg vizes dézsza;
RM acélpántolat;
Belső fa padozat;
Vízleengedő szelep;
Lépcső

Kiegészítők



Belső kazánok

RM acélkazán, 430-as standard anyagból, 5 hőcserélővel. Kettős kéménnyel, kürtőfedővel. Teljesítmény: 12-14 KW. A "Standard" kazán ideális 1.5 és 1.9m-es átmérőjű dézsákhoz. A "Nagy" kazán a 2.2m-es átmérőjű dézsákhoz ajánlott..



Standard külső kazán

A külső kazán helyet takarít meg a fűthető dézsában. Teljesítménye: 16KW



Külső kazán, üvegajtóval.

Nagyon hatékony, teljesítménye: 18KW. A kémény particionálásával növelhető a kazán teljesítménye.



RM hővédő szett

Megvéd az esetleges kémény okozta sérülésektől.



Fa védőkorlát kéményhez

Skandináv fenyőből. Megóv a forró kémény okozta sérülésektől.



Ponyva

Megóv a külső szennyeződésektől.



Fa fedő dézsákhoz

Segít a vízminőség hosszan tartó megőrzésében. 1.5m-es fedő 2db-ból, az 1.9 ill. 2.2m-es dézsza fedők 3 db-ból állnak. A hideg vizes dézsákhoz a fedő 1db-ből áll.



Üvegszövet kompozit tető, 1.8m-es kompozit dézsához

Segít a jobb vízminőség megőrzésében. Választható színek: krém (RAL9001) kék (RAL5012).



Pohár vagy üvegtartó

Fenyőből öt lyukkal



Keverő lapát

Hossza- 177 cm, szélesség – 5 cm; lapátfej magassága – 14 cm; vastagság – 2.5 cm.



Tisztítók

Kazán tisztításhoz és tűz kezeléshez. 82cm fa nyéllel.



Led lámpa

Színváltós, vízálló. Erőforrás: 4 x AAA elemek (nem tartozék) Méret: 11 x 4.5 cm.



Dupla lépcső

Skandináv fenyőből. Magasság – 55 cm; szélesség – 55 cm.



Hármas lépcső

Skandináv fenyőből. Magasság – 65 cm; szélesség – 50 cm.