

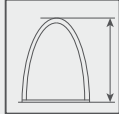

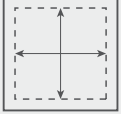
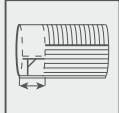
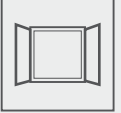
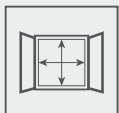
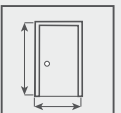

**Camping  
products**

# Camping pods (m) 4 4.8

	2600 mm		7.5 m <sup>2</sup> 9.3 m <sup>2</sup>
	600 mm		1
	715 x 675 mm		1020 x 1900 mm
	Spruce		38 mm
	2 - 4		1300 kg 1600 kg
	Not assembled 4 x 1.2 x 2.6 m; 4.8 x 1.2 x 2.6 m Assembled 4 x 2.4 x 2.6 m; 5 x 2.4 x 2.6 m		

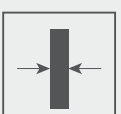

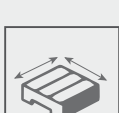
Standard set:

- Pod made from spruce;
- Roof covered with bitumen shingles of your selected color;
- Opening window in the back wall;
- Double doors with a lock and the double glass windows;
- Camping Pod 4 m has one large room inside.

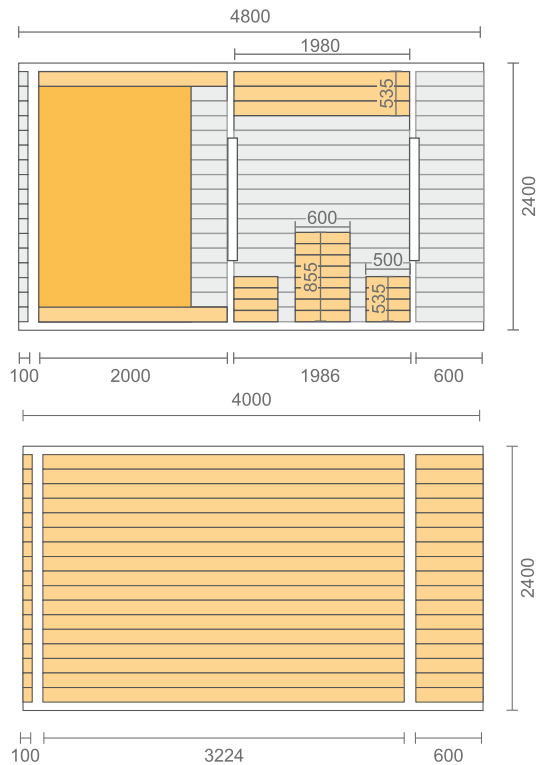



# Barrel for sleeping 4



	2400 mm		4000 mm
	300 mm		690 x 1800 mm
	1		715 x 675 mm
	Spruce		1000 kg
	2 - 4		38 mm
	Not assembled 4 x 1.2 x 2.5 m Assembled 4 x 2.35 x 2.5 m		

## Standard set:

- Barrel made from spruce;
- Roof covered with bitumen shingles of your selected color;
- Stainless steel tightening bands;
- Opening window in the back wall;
- Doors with a lock and a hexagon window;
- Two rooms inside: a sleeping room and a sitting room;
- Sitting room with a sliding table, two benches and back rests which can be transformed to additional bed;
- Sleeping room with a sleeping space: 2 x 2 m;
- Small benches at the entrance.

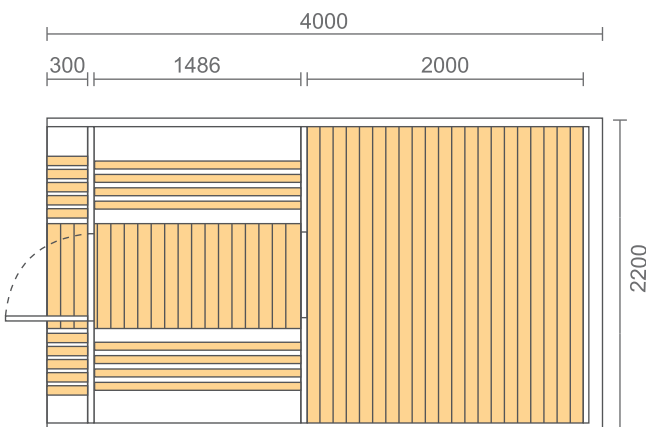

# Insulated camping pod

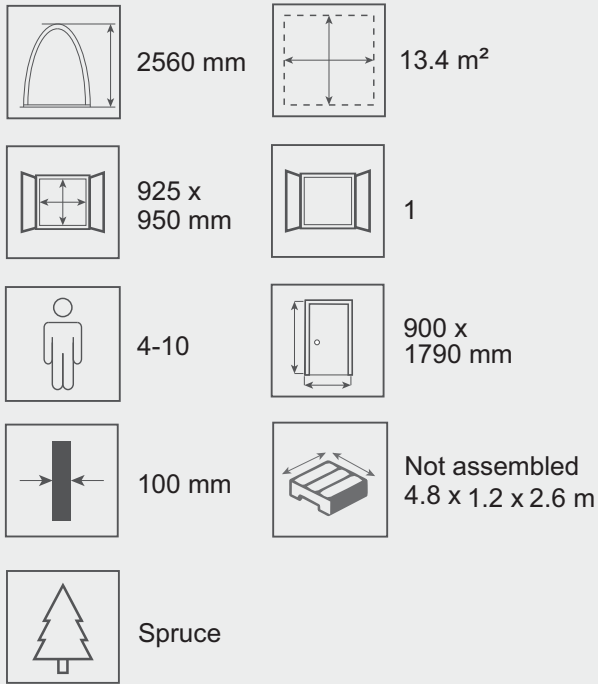

## Standard set:

- Pod made from spruce with insulated walls;
- Roof covered with bitumen shingles of your selected color;
- Opening window in the back wall;
- Double doors with a lock and the double glass windows;
- Two rooms inside.

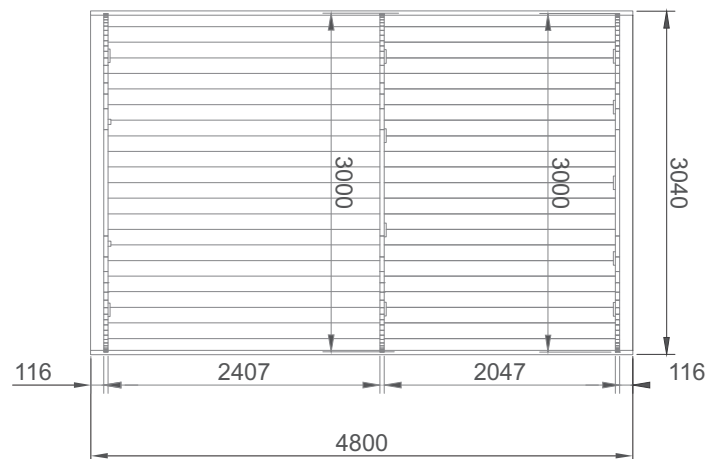

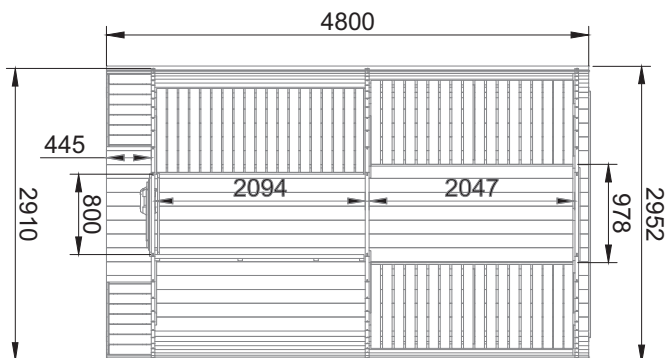
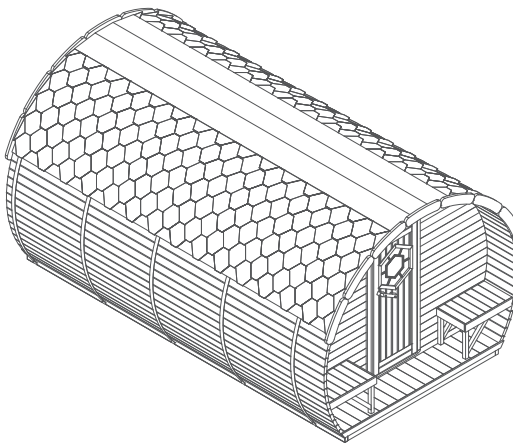
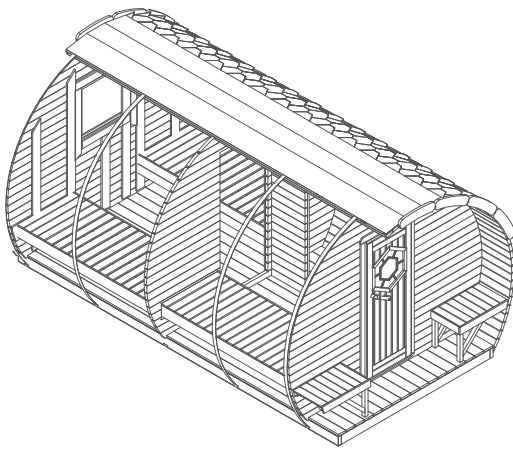

# Barrel „Ice Viking“

	2500 mm		9.5 m <sup>2</sup>
	1		Spruce
	830 x 756 mm		1
	4-10		700 x 1725 mm
	38 mm		1880 kg
	Not assembled 4.8 x 1.2 x 1.5 m		

## Standard set:

- Pod made from spruce with insulated walls;
- Roof covered with bitumen shingles of your selected color;
- Opening window in the back wall;
- Double doors with a lock and the double glass windows;
- Two rooms inside.

