

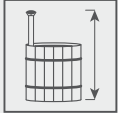

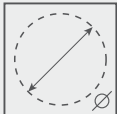



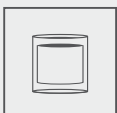
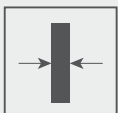

**Hot tubs**

# Hot tubs

Wooden

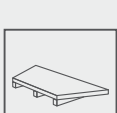
	1050 mm		2390 mm
	1.5 m 1.9 m 2.2 m		Round
	1600 l 2550 l 3420 l		38 mm
	Spruce		Thermo wood
	5 - 10		170 - 300 kg
	5 or 8		
			
	Not assembled 2.2 x 1.2 x 0.63 m; 2 x 1.2 x 0.6 m Assembled 1.7 x 1.2 x 1.9 m; 2.1 x 1.2 x 2.2 m; 2.3 x 1.2 x 2.4 m		

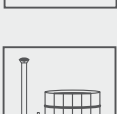
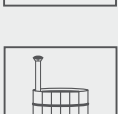
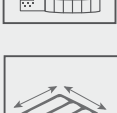



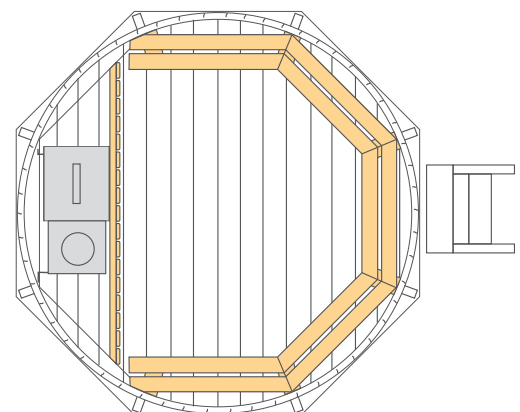
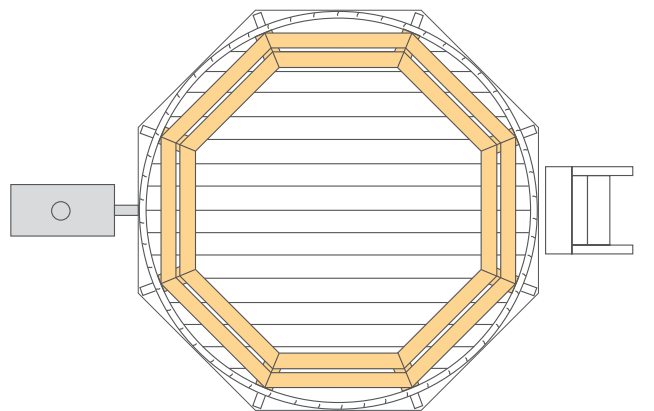



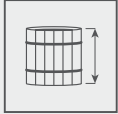
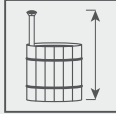
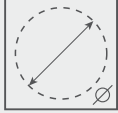

**Standard set:**

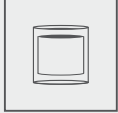
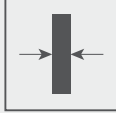
- Wooden hot tub;
- Stainless steel tightening bands;
- Stainless steel heater with a chimney (internal or external);
- Wooden inside benches;
- Safety fence for the hot tubs with the internal heaters;
- Outlet valve for water;
- Stairs.



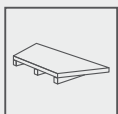

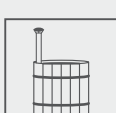
## Hot tubs Polypropylene

	950 mm		2390 mm
	1.5 m 1.9 m 2.2 m		Round
	1600 l 2550 l 3420 l		12 + 8 mm
	Spruce		Thermo wood
	5 - 10		200 - 250 kg
	5 or 8		
			
	Assembled 1.6 x 1.2 x 1.8 m; 2 x 1.2 x 2.1 m; 2.3 x 1.2 x 2.4 m		

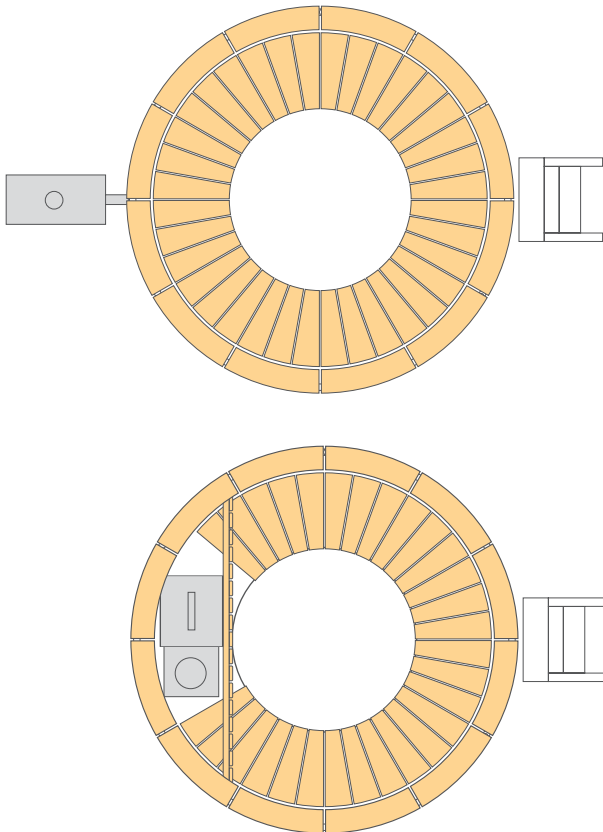









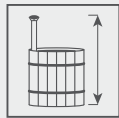

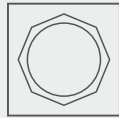
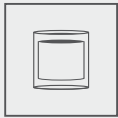
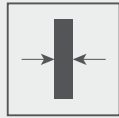
### Standard set:

- Wooden hot tub with inside polypropylene frame;
- Stainless steel tightening bands;
- Stainless steel heater with a chimney (internal or external);
- Wooden inside benches;
- Safety fence for the hot tubs with the internal heaters;
- Outlet valve for water;
- Stairs.

# Hot tubs

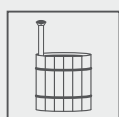
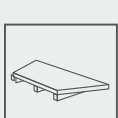
Fiberglass

	850 mm 1000 mm		2390 mm
	1.8 m		Round
	1300 l 1600 l		38 + ~3 mm
	Spruce		
	4-8		200 - 230 kg
			
	1		Assembled 2.1 x 2.1 x 1.25

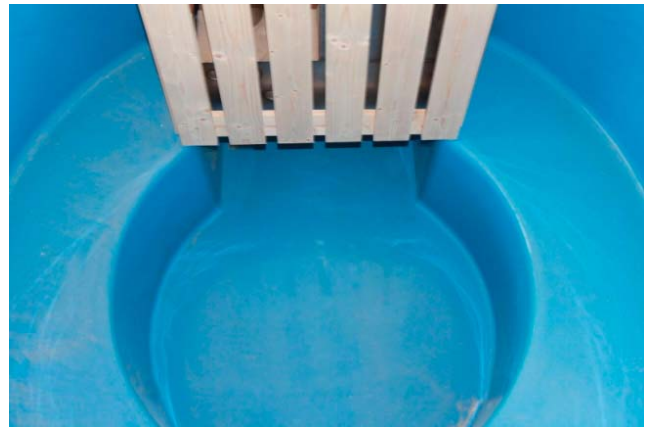

## Standard set:

- Fiberglass frame hot tub with wooden finishing from the outside;
- Stainless steel heater with a chimney (internal or external);
- Fiberglass inside benches;
- Safety fence for the hot tubs with the internal heaters;
- Outlet valve for water;
- Stairs.

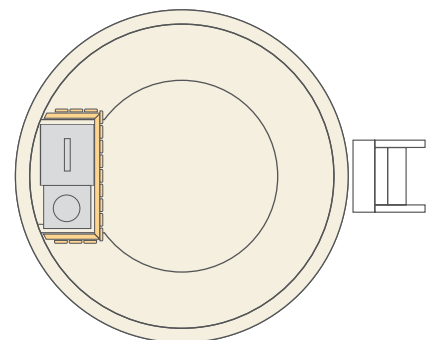
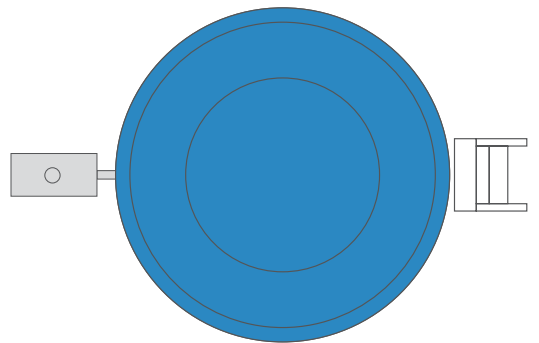

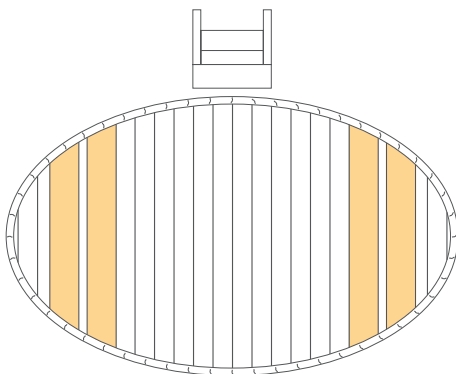
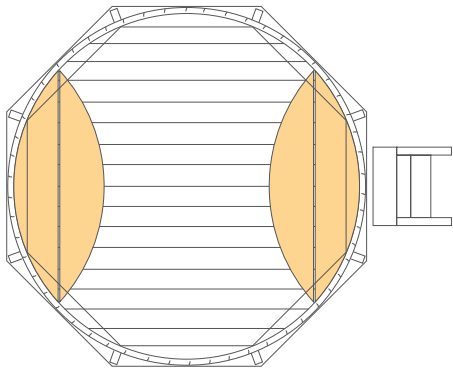

## Cold tubs

Oval

Round

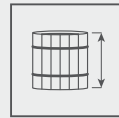

1000 mm

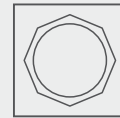

Round  
Oval

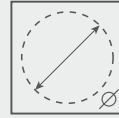

1.2 m

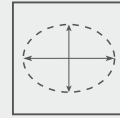

1500 x 850 mm

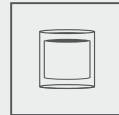

1600 l  
2550 l

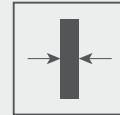

38 mm



Spruce

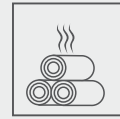

Thermo wood

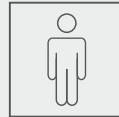

1 - 2



150 - 115 kg

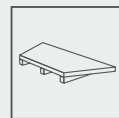

2

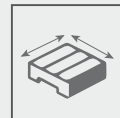

Not assembled  
1.1 x 1.4 x 0.6 m;  
1.1 x 1.6 x 0.6 m  
Assembled  
1.4 x 1.4 x 1.25 m;  
1.1 x 1.6 x 0.95 m

### Standard set:

- Wooden cold tub;
- Stainless steel tightening bands;
- Wooden benches inside;
- Outlet valve for water;
- Stairs.

# Accessories



### Inside heater

A stainless steel (430) heater which has five culverts for the water circulation. Two chimney tubes and a roof.

Power is 12-14 KW. Standard heater is suitable for 1.5 m and 1.9 m diameter hot tubs. Large heater is suitable for 2.2 m diameter hot tubs.



### Standard external wood burning heater

External wood burning heater. Power is 16 KW. An external heater will help you to save a space in the tub for at least two persons.



### External wood burning hot tub heater with a glass.

Very powerful external wood burning heater for a hot tub. Power is 18 KW. Heater has the glass in the door, so it looks like a small fireplace. Partition before a chimney increases heater's performance.



### Metal safety fence for a hot tub chimney

Safety fence is made from stainless steel. It makes a proper distance from hot wood burning heater chimney.



### Wooden safety fence for a hot tub chimney

Safety fence is made from spruce wood. It makes a proper distance from hot wood burning heater chimney.



### Tent cover

Tent cover for the hot and cold tubs helps to keep the water clean for a longer time.



### Wooden cover

Wooden cover for a tubs helps to keep the water clean for a longer time. 1.5 m diameter cover consists of 2 parts; 1.9 m and 2.2 m diameter covers consist of 3 parts; cold tubs cover - of 1 part.



### Fiber glass cover for 1.8 m fiber glass hot tub

Fiber glass cover for 1.8 m fiber glass hot tub. Fiber glass cover designed for a fiber glass hot tub helps to keep the water clean for a longer time. Available colors: cream (RAL9001) and blue (RAL5012).



### Bottle holder

Bottle holder made from spruce for 5 bottles.



### Paddle made from spruce

A paddle to stir water. Length of the handle – 177 cm, width – 5 cm; width of the shoulder – 14 cm; thickness – 2.5 cm.



### Scoop and poker

A scoop and a poker with the wooden handles for the cleaning and maintenance of the hot tub heater. It's 82 cm length.



### Led Light

LED waterproof light with an automatic color change. The light is powered with 4 x AAA batteries (not included). Size: 11 x 4.5 cm.



### Stairs "2 steps" for hot tubs

Wooden stairs made from spruce. Height – 55 cm; width – 55 cm.



### Stairs "3 steps" for hot tubs

Wooden stairs made from spruce. Height – 65 cm; width – 50 cm.